

# Enclosure Experts: Designing an Effective Conservation Technology Enclosure

By Ashley Rosen



*This project was a collaboration between a student at the Duke University Pratt School of Engineering and the WWF-US Wildlife Crime Technology Project.*

Ashley Rosen's interviews with all three experts who assisted with the creation of this guide can be found on WILDLABS at the following links:

[Enclosure Expert Interview: Eric Becker](#)

[Enclosure Expert Interview: Tim van Dam](#)

[Enclosure Expert Interview: Juan Swart](#)

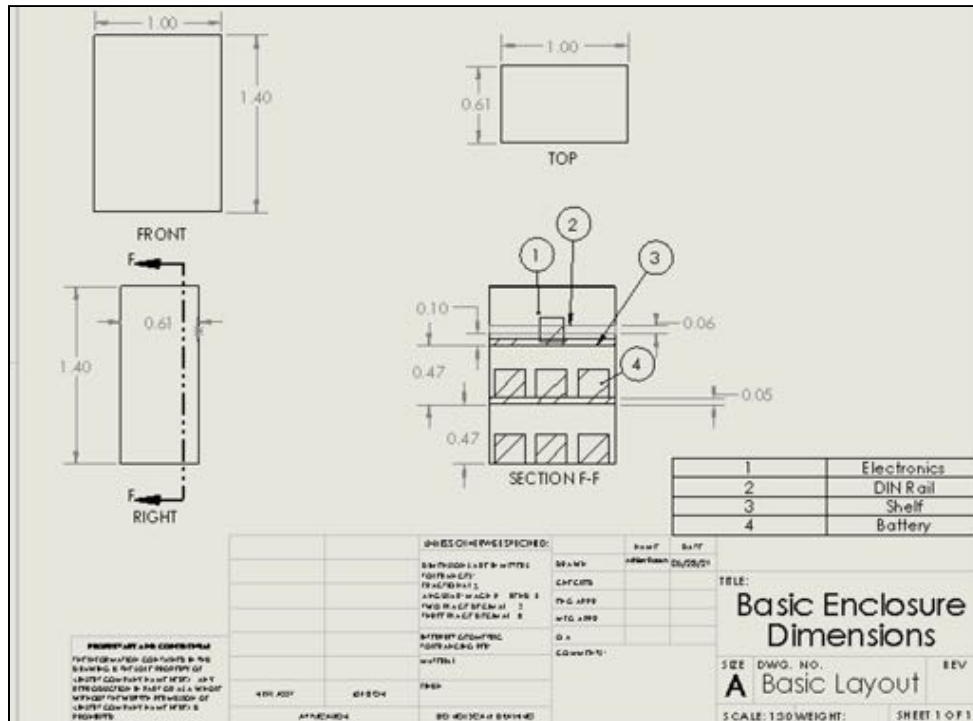

*Thanks to Eric Becker, Tim van Dam, and Juan Swart for their contributions to this research and series.*

## **I. Goal**

The goal of this project was to determine best practices for passively-cooled enclosures used in harsh environments. Harsh was defined as high temperature, humidity, and precipitation. The enclosures are meant to store batteries, networking equipment, and other technology needed to monitor wildlife in protected areas. The enclosures should maximize airflow to ensure any enclosed batteries have proper ventilation. They should minimize temperature and prevent moisture from getting in. The enclosures must also be animal and insect resistant.

## **II. Approach**

Three interviews were conducted with experts in the field of conservation tech: Eric Becker from World Wildlife Fund, Tim van Dam from SmartParks, and Juan Swart from Techlink to hear about and learn from their experiences with enclosures.

Based on their feedback and research on existing enclosures, I created 7 CAD models of different passively cooled enclosures with SolidWorks. I conducted flow simulations on these models, where air temperature was 48 Celsius, modeling the highest temperatures that may occur, to determine which enclosure types had the most airflow and lowest temperatures. All enclosures had the same base shape and dimensions. They differed by the number and placement of cutouts and louvers, which were used for passive cooling.

A scale model of one of the designs was built and tested.

## **III. General Tips for Anyone Building an Enclosure**

The enclosure designs and findings presented below were based on specific dimensions, and they were tested under specific conditions. From the interviews, there were general tips that would apply to anyone building an enclosure, regardless of its dimensions or conditions. These general tips are given here:

- A. Seal the enclosure as much as you can by using cable glands for any wiring going into or out of the enclosure to prevent water infiltration.<sup>1</sup>

---

<sup>1</sup> This tip is from Tim van Dam. To hear more about his work, [see his interview on WILDLABS](#).

- B. Based on the technology used in your project, the maximum acceptable temperature and humidity values may vary. Make sure to look at the spec sheets for the products you are using to determine what is needed for your project.
- C. When you can, use sealants or coatings to protect circuit boards and other electronics from water damage. This does not mean the electronics can be left out in the rain or submerged in water, but it will help provide additional protection.
- D. Carefully consider where you are mounting your electronics and batteries. You want them to be near areas with airflow so batteries can off-gas safely and the electronics are as cool as possible. However, you also want to ensure they are safe from rain. Mounting electronics on the bottom of an enclosure is not recommended, as water may pool here. Adding drip holes, drains, or a cutout with a mesh screen can help the water escape from the bottom.
- E. Dust can accumulate inside enclosures. If possible, maintain the interior of the enclosure, and clean any dust that accumulates.<sup>2</sup>
- F. Grounding or Earthing is essential for enclosures. This is needed to keep the enclosure and anyone interacting with it safe from shortages or failures with the electronics. Make sure to follow all wiring codes and applicable electrical standards when building your enclosure to ensure it is safe.
- G. Heat and rain are large contributors to enclosure failure. To keep rain off of the enclosure and keep it cool, consider placing your enclosure under a solar panel or covered area to keep it shaded and shielded from the weather.
- H. Tampering may be a concern for your project. To improve the tamper-resistance of your enclosure, ensure any cutouts are covered with a strong steel mesh that cannot be cut with wire cutters. If the enclosure is elevated off the ground to allow for air circulation, make sure it is not so high off the ground that a person could fit underneath it and try to cut through any mesh that may be there. Padlocks and tamper-resistant hinges may further improve security. Moreover, if the door is set back into the enclosure and surrounded by a lip, it will be more difficult for a crowbar to be used to open the door and remove the electronics. Carefully consider the weight distribution in the enclosure, so that the enclosure contents are configured in a way that makes the enclosure more difficult to tip or move.

---

<sup>2</sup> Tips B-E are from Eric Becker. To learn more about his work, [see his interview on WILDLABS](#).

- I. Grasses and plants can grow quickly, depending on the enclosure location, and affect the air circulation in the enclosure. If possible, maintain a clear area around the enclosure.<sup>3</sup>

#### IV. Optimal Designs

Of the 7 CAD models that were created and analyzed, the design with the lowest temperature (Design 6) and most airflow (Design 7) that I modeled are shown below.

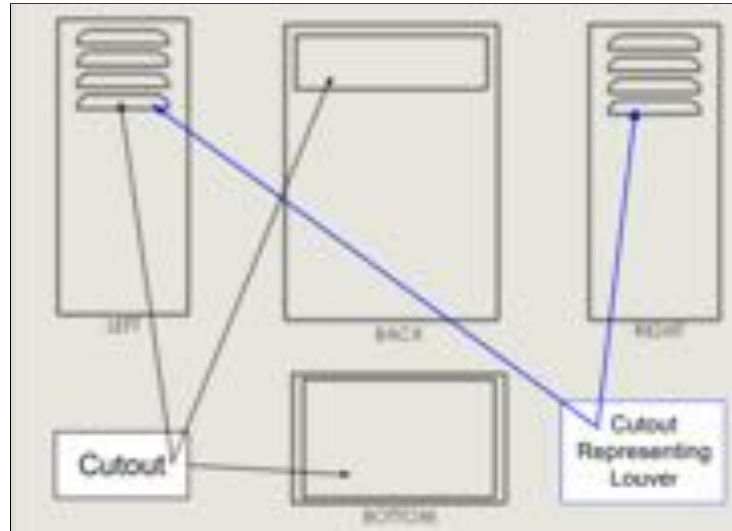
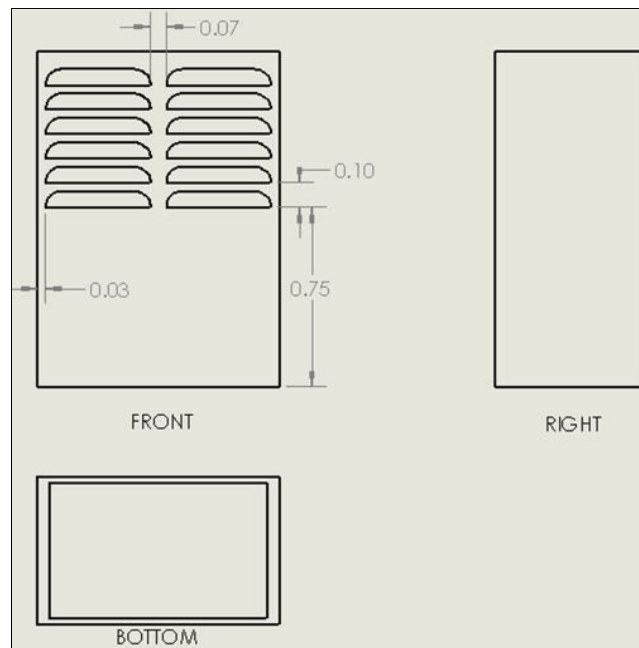

Figure 1: Design with Lowest Temperatures



<sup>3</sup> Tips F-I were provided by Juan Swart. To learn more about his work, [see his interview on WILDLABS](#).

Figure 2: Design with Most Airflow

Design 6 with the lowest temperatures consists of a cutout on the bottom, a cutout on the back wall where the electronics are mounted, louvers on the top left side, and louvers on the top right side. While not included in the CAD, an important feature of this design is an overhang to prevent rain from blowing into the cutout on the back.

Design 7 with the most airflow consists of a cutout on the bottom and louvers on the front side of the enclosure.

All designs included a cutout on the bottom as shown in Figure 1. The designs differed from each other by the number and location of other cutouts and louvers.

## V. CAD

The models were designed and analyzed in SolidWorks. While SolidWorks is not free, there is free software available, such as Fusion 360 and SimScale, that would allow you to do a similar analysis to the one described in this article.

All of the models were made of cold-rolled steel that was 1mm thick, as this was the most widely available and affordable metal used by Juan and Eric. A thickness of 1mm was chosen, as it is still affordable but provides some weight to prevent the enclosure from being moved.

All models had the same base dimensions as shown below. These were based on enclosure sizes previously used by Eric Becker at WWF and Juan Swart from Techlink.

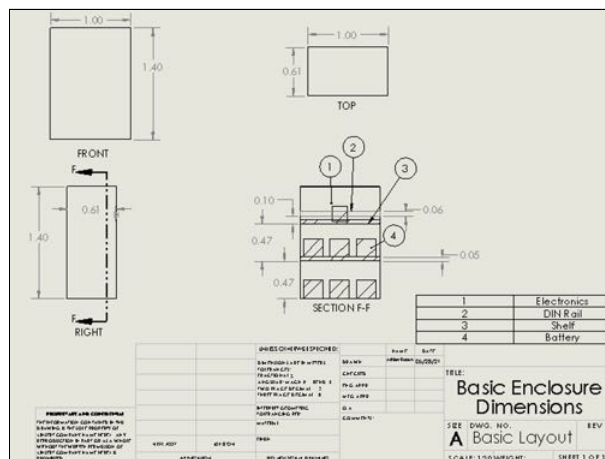

Figure 3: Basic Dimensions of Enclosure Models in Meters

Seven enclosure models were designed and tested. They had the same dimensions and components as shown above in Figure 3. Unless stated otherwise, all enclosure dimensions are in meters. All models also had a cutout on the bottom and additional cutouts and louvers to allow for passive ventilation. This bottom cutout can be seen in Figure 4 below. Air exited through the bottom cutout on all enclosures.

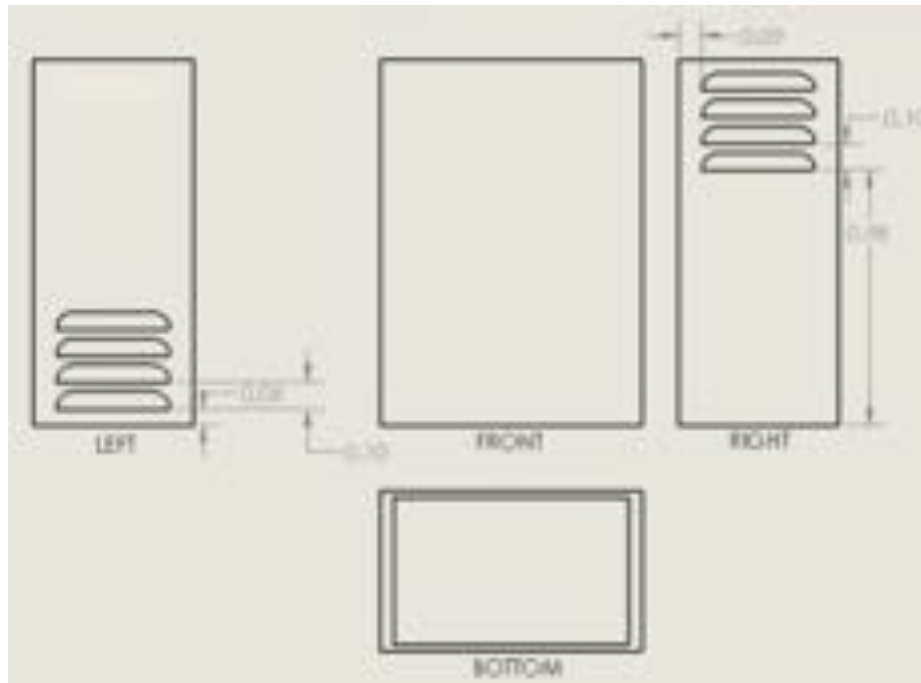

Figure 4: Design 1

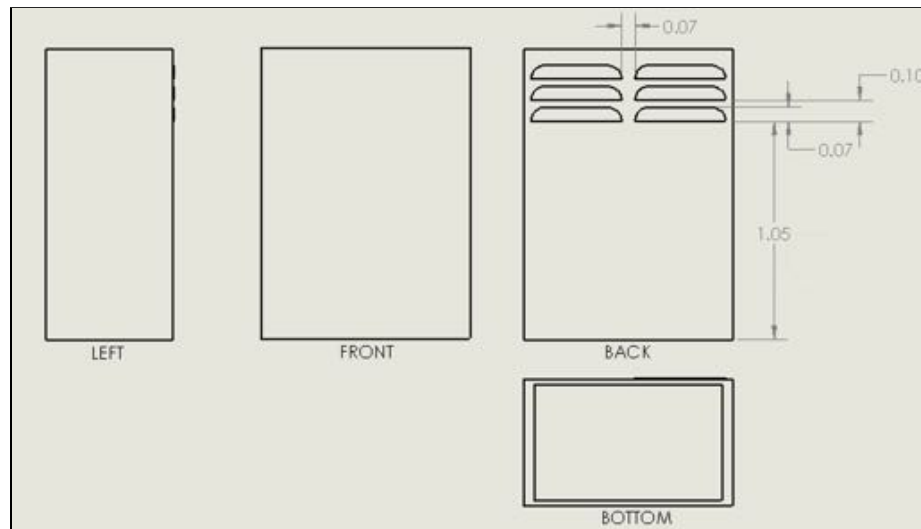

Figure 5: Design 2

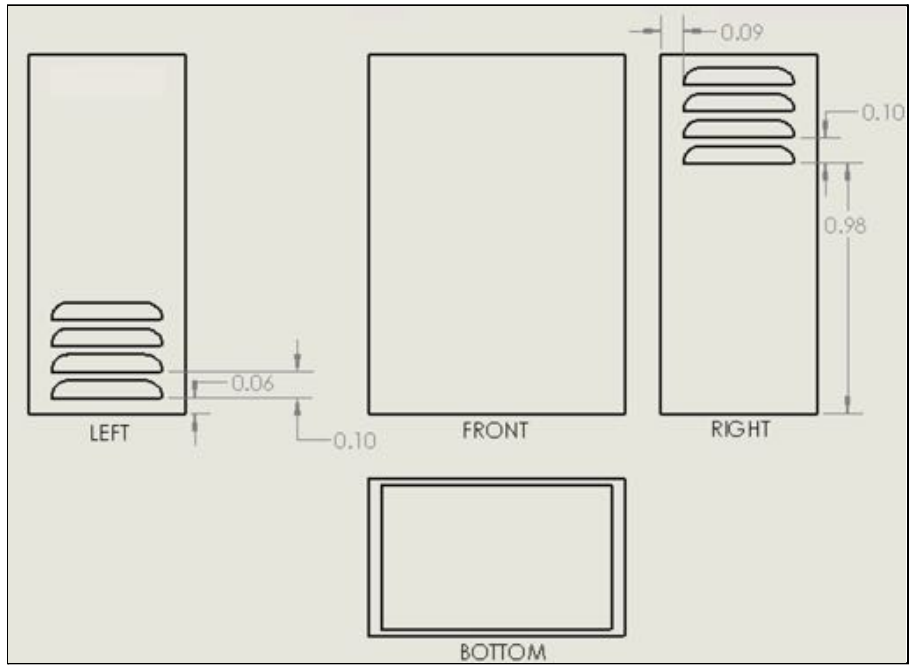

Figure 6: Design 3

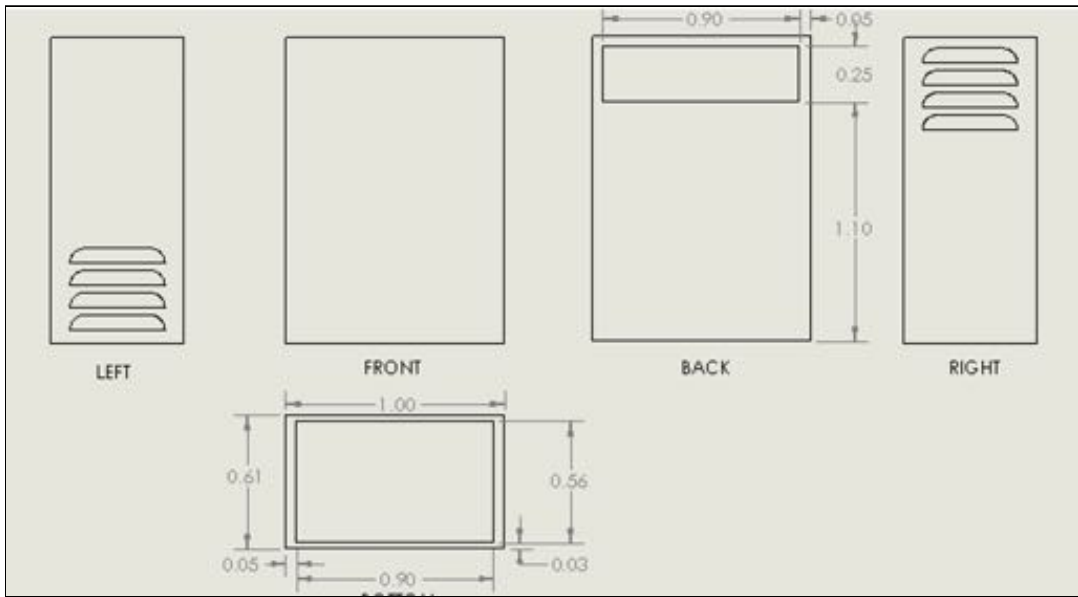

Figure 7: Design 4



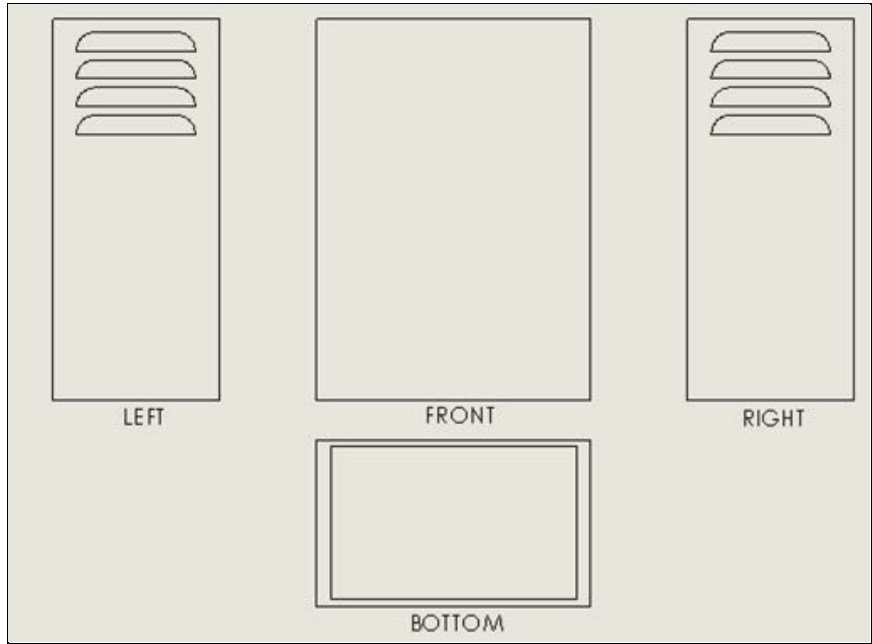

Figure 8: Design 5

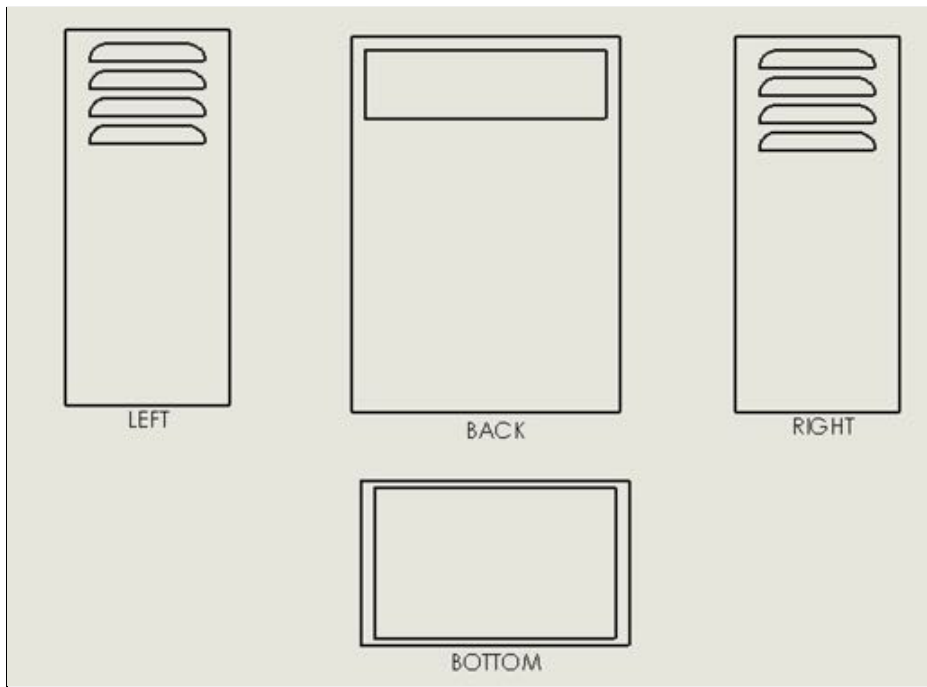

Figure 9: Design 6

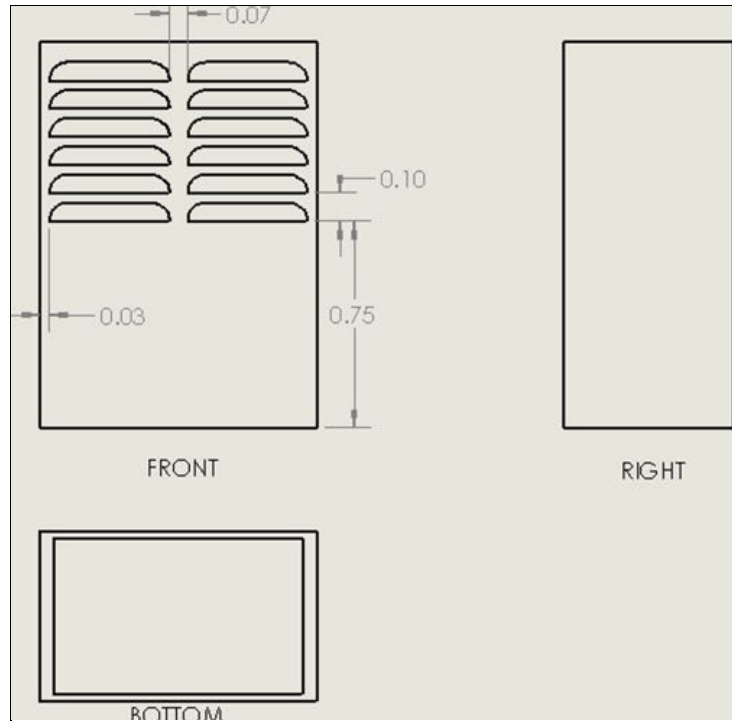

Figure 10: Design 7

To compare the models, I performed flow simulations and looked at the volumetric flowrate of air exiting through the bottom cutout, the average temperature of the electronics, the maximum air temperature of a cross section through the middle of the enclosure, and the highest temperature on the enclosure walls. The temperature of the air and starting temperature of all components was set at 48 Celsius, as this is the highest temperature that Juan has experienced while developing enclosures in Zambia.

Initially, thermal simulations were performed, but this would not allow for volumetric flowrate to be calculated or accurately represent heat transfer between the air and internal walls of the enclosure.

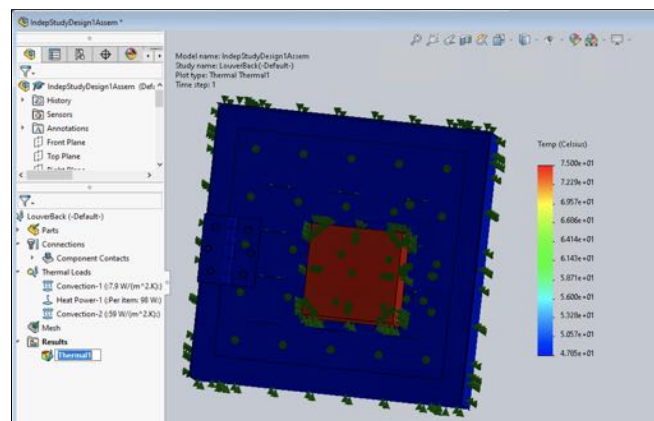

Figure 11: Thermal Analysis Example

Depending on each individual project, every enclosure will have different needs and electrical components. Some common electronics used in enclosures include fiber converters, routers, ethernet switches, and power converters. For this project, I focused on the temperature ranges, humidity limitations, and power consumption of the Cisco IR829 router, Cisco IE3200 networking switch, and Cisco DC-DC power module for POE converter, as they were responsible for generating the most heat in enclosures used by World Wildlife Fund in the past. The router allows for services like 4G LTE and Ethernet, the switch allows for Gigabit Ethernet connectivity, and the power module acts as a converter. These three components had a combined volume of 412.346 in<sup>3</sup>. I modeled them as one 7.44 in. cube. These three components consumed a total of 98 Watts of electricity. I focused on power consumption for my analysis, as this is related to heat output from electronics.

To connect the electronics cube to the rest of the enclosure to allow for heat conduction to the enclosure walls, I mounted the cube to a rail. Both the rail and electronics were made of aluminum.

Electronics need a power source, and for remote conservation projects, solar power can be a great option. This requires the use of additional components like converters and batteries. Batteries can take up a significant amount of space, which obstructs airflow in the enclosure. To accurately model airflow for my simulation, I added shelves and 6 batteries to my models as shown below. The dimensions of the shelves, rail (called a DIN rail), and batteries were based off of those used in past enclosures by World Wildlife Fund. These components may also be seen in the section view in Figure 3.

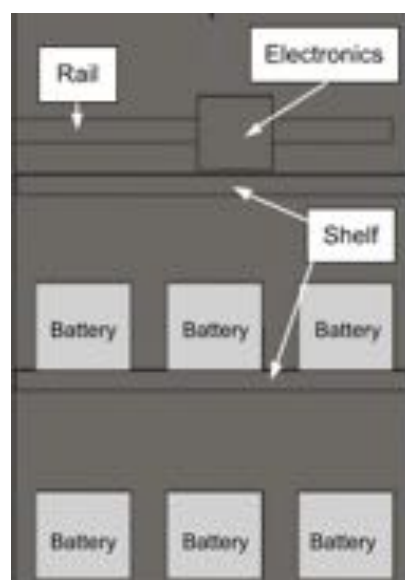

Figure 12: Internal Layout of Enclosures-- View of Back Wall

To run the simulation, all openings in the enclosure were set at environmental pressure and temperature so that the software understood that air was passing through these regions. The openings were treated as perforated surfaces in SolidWorks, as any vents or cutouts used in real enclosures must be covered by a mesh or screen to prevent insects from getting in, but restricting airflow.

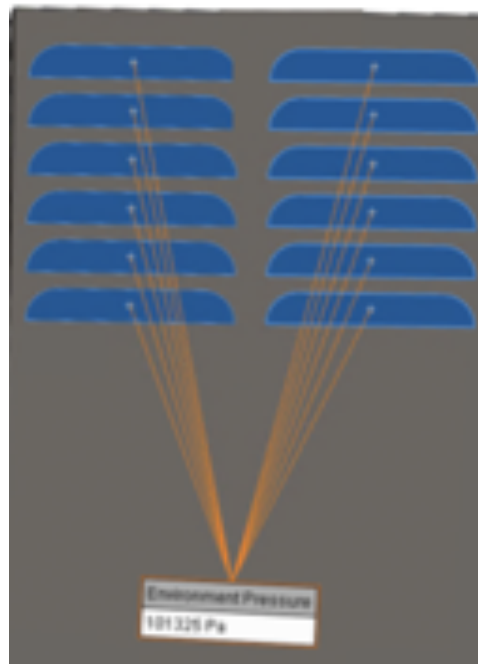

Figure 13: Environmental Pressure Example

I created a custom perforated surface and modified the free area (ratio of open surface to covered surface of a material). To determine the free area of the mesh, I looked at steel meshes on McMaster-Carr. Juan from TechLink often uses a steel mesh with a 2-3 mm (0.079- 0.118 in.) opening and a layer of expanded metal to keep insects out. I based my free area calculations on the steel mesh, as this would be the most restrictive of airflow. The closest approximation to mesh with a 2-3 mm opening was [steel mesh](#) with an opening that is 0.06 in. wide and 0.1 in. long. The shape of this opening was a diamond. The width of the metal used in the mesh was 0.016 inches, and the thickness was 0.015 inches. A 12 inch x 12 inch sheet of the metal would have an area of 144 in<sup>2</sup>. Each diamond has a width of 0.06+2(0.016) in. and length of 0.1+2(0.016) in. We can use the equation: Area= Length\*Width\*0.5 to get the total area of (0.1+2(0.016))\*(0.06+2(0.016))\*0.5=0.006072 in<sup>2</sup>. The interior of the diamonds without the metal has dimensions of 0.06 in. and 0.1 in., so the area is 0.5\*0.1\*0.06=0.003 in<sup>2</sup>. Subtracting interior from exterior, the area filled with material is: 0.003072 in<sup>2</sup>. If we divide the area of the 12 in. x 12 in. sheet by the area of the diamond including metal,

we find we can fit 23,715.42 diamonds onto the sheet. If we multiply this by the open area per diamond, we find the open area of the sheet to be 71.14. Thus, the free area ratio is **0.494**.

## **Meshing**

During a flow simulation, SolidWorks divides objects into small particles and analyzes them. The more particles an object is divided into, the more accurate your results will be. The more particles you have, the longer it takes to run the simulation. SolidWorks allows you to increase or decrease the number of particles by changing the mesh. A higher mesh (the highest is 7) is much finer, and thus has more particles than a lower mesh (such as 2).

For my simulation, all models were analyzed at a mesh of 5, with the exception of Design 1, which was run at a 6. These were the highest meshes possible, as the simulation would fail if I tried a higher mesh. A different computer with more operating power would have been able to run the simulations at a higher mesh.

The meshing also impacted the size of the louvers on the models. I based the size of the louvers on those found on [McMaster-Carr](#). These louvers were 8.5 in wide and 1.1 in tall. However, when I went to create the mesh, the simulation failed. To address this, I doubled the size of the louvers and cut the number of louvers in half. The final louver dimensions can be seen here:

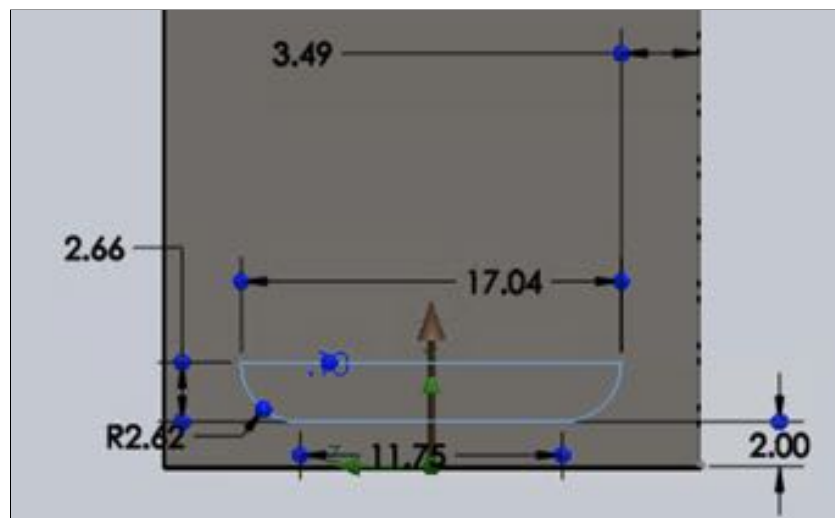

Figure 14: Louver Dimensions in Inches

## H Value

To accurately model heat transfer through the enclosure walls in SolidWorks, a coefficient of heat transfer,  $h$ , is needed. This is based on thermal properties of the material, the maximum and minimum temperatures, and height. A value of 0 (meaning there is no heat transfer through the enclosure walls), 2, and 5 W/m<sup>2</sup>K were tested. 2 and 5 W/m<sup>2</sup>K were tested under the advice of Dr. Nico Hotz from the Pratt School of Engineering at Duke University. The data for 2 W/m<sup>2</sup>K is shown below in Table 1. 2 W/m<sup>2</sup>K was selected, as it was a more conservative estimate than 5, representing the worst case scenario while still allowing for some heat transfer through the walls.

## Results:

Table 1: Results Ranked from Lowest to Highest Temperature

Design	Max Wall Temperature (°C)	Max Air Cross Section Temperature (°C)	Average Electronics Temperature (°C)	Volumetric Flowrate Through Bottom Cutout (m <sup>3</sup> /s)
6	78.43	78.31	78.31	0.0039
4	79.36	79.23	79.24	0.0054 <sup>4</sup>
5	79.55	79.45	79.41	0.0039 <sup>5</sup>
2	80.59	80.47	80.47	0.0030
3	81.10	80.94	80.95	0.0066 <sup>6</sup>
7	81.62	81.47	81.47	0.0201
1	82.0	81.85	81.89	0.0026
Box Without <sup>7</sup> Cutouts	89.71	89.68	89.58	---

<sup>4</sup> An additional 0.0013 m<sup>3</sup>/s of air exited the bottom left louver and 0.0002 m<sup>3</sup>/s exited the last top right louver

<sup>5</sup> An additional 0.0001 m<sup>3</sup>/s of air exited the bottom right louver

<sup>6</sup> An additional 0.0012 m<sup>3</sup>/s of air exited the bottom left louver

<sup>7</sup> Because this was an internal flow simulation, some air needed to enter the enclosure. This was done through a 0.35 in. hole, which is very small relative to the enclosure and cutouts on the other models.

Table 2: Results Ranked from Highest to Lowest Flowrate

Design	Max Wall Temperature (°C)	Max Air Cross Section Temperature (°C)	Average Electronics Temperature (°C)	Volumetric Flowrate Through Bottom Cutout (m <sup>3</sup> /s)
7	81.62	81.47	81.47	0.0201
3	81.10	80.94	80.95	0.0066
4	79.36	79.23	79.24	0.0054
6	78.43	78.31	78.31	0.0039
5	79.55	79.45	79.41	0.0039
2	80.59	80.47	80.47	0.0030
1	82.0	81.85	81.89	0.0026

As illustrated by the tables, Design 7 had the most amount of airflow, but it also had the second highest temperatures. Design 6 had the lowest temperatures but a lower airflow.

If airflow is a more important concern than temperature, Design 7 may work better for your application. Different batteries behave differently when charging, discharging, and overheating. For example, lead acid batteries may produce hydrogen and oxygen while charging. This gas can build up if there is not enough ventilation, causing a fire or even an explosion. Thus, if many lead acid batteries are being used for your application, and the batteries and technology you have selected can withstand higher temperatures, Design 7 may be the best choice. To learn about batteries and how they can fail, [read more here.](#)

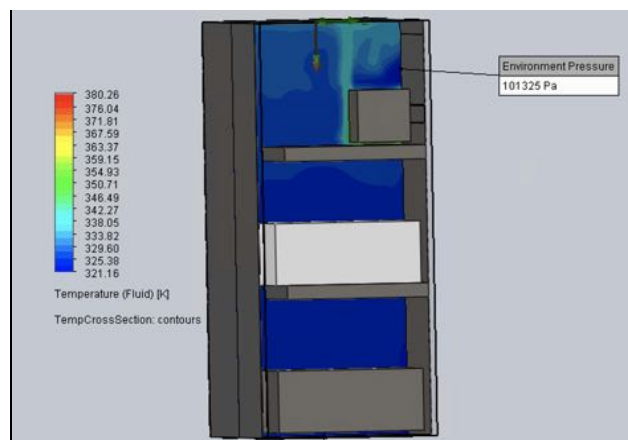

Figure 15: Example of Max Air Cross Section Temperature

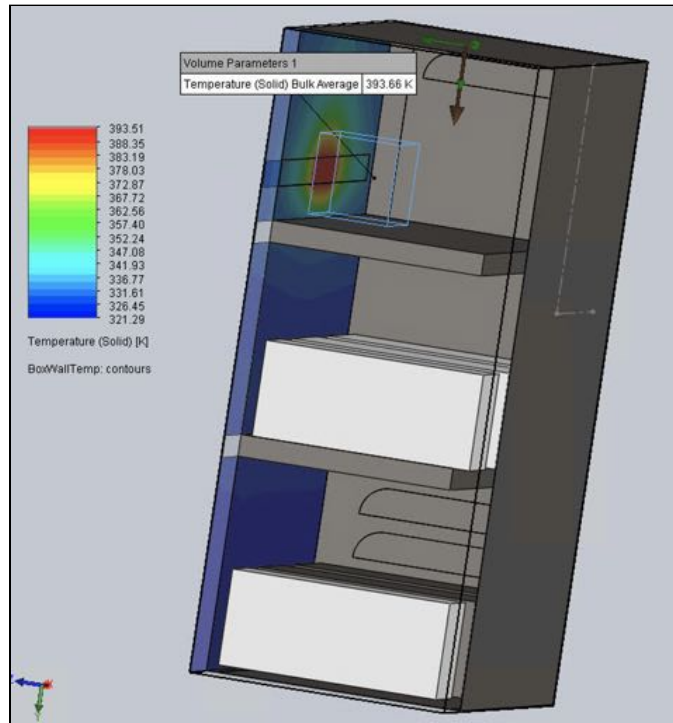

Figure 16: Example of Average Electronics Temperature and Max Wall Temperature

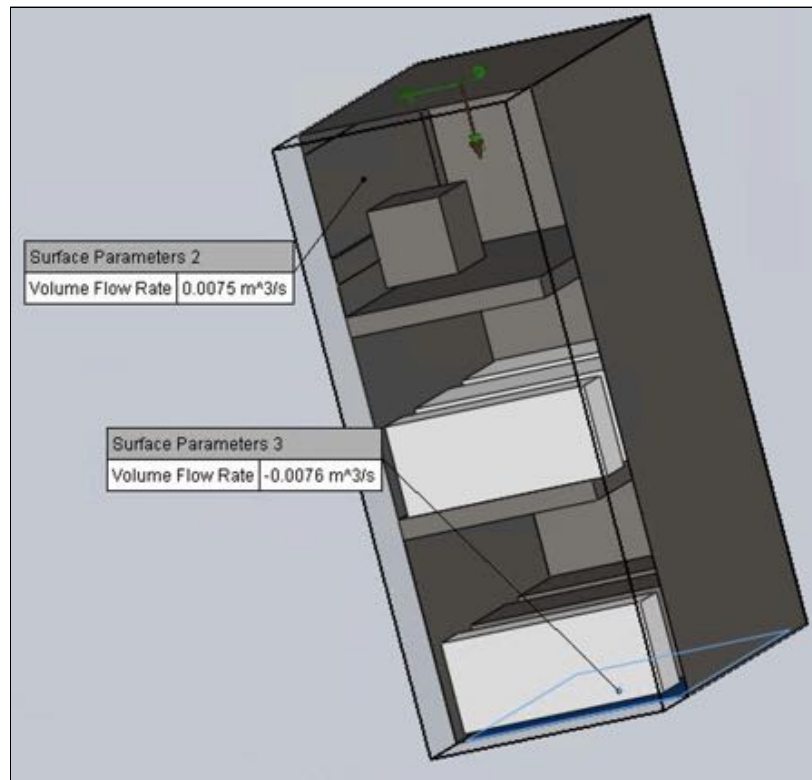



Figure 17: Example of Volumetric Flowrate Through Bottom Cutout

## VI. Physical Model

A scale prototype of Design 4 was constructed, as it had the second lowest temperatures and a higher airflow than Design 6, so it optimized the two most important features: airflow and temperature.

The scale model was  $\frac{1}{3}$  the size of the full-size model. Its dimensions can be seen here:

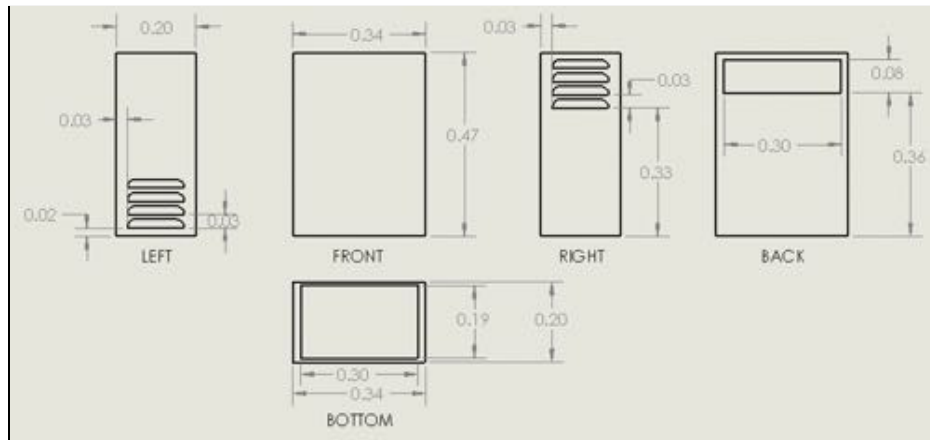

Figure 18: Dimensions of Scale Model in Meters

The model was made of 0.0359 in. thick A366/1008 cold rolled mild steel, louvers, 80-20 channel, expanded metal, and mesh. The expanded metal, mesh, and 80-20 were supplied by the Pratt School of Engineering Material Science and Mechanical Engineering Department.

To construct the model, cutouts for the louvers and open areas were made with a waterjet at the Duke University Innovation Co-Lab. Illustrator drawings were made and uploaded to the waterjet so that it could correctly make the needed cutouts.

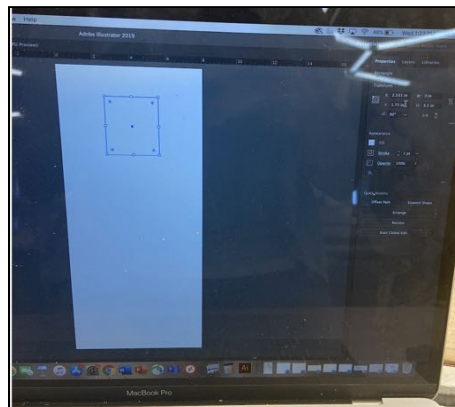

Figure 19: Example Illustrator File

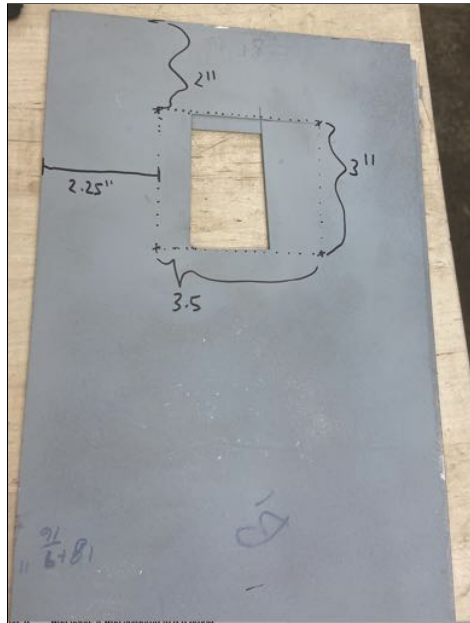

Figure 20: Enclosure Side Cut With Water Jet

A drill press and hand drill were used to make holes to attach the sheet metal to the 80-2-0 channel and attach the louvers to the metal. To prevent rusting, the sheet metal was coated with a primer and paint. Further, grommets were used around the holes to stop water infiltration.

A 44° overhang to protect the back cutout was made by bending the end of a piece of sheet metal with a foot shear. The sheet metal was then attached to the top of the scale enclosure model to cover the cutout in the back. A door and shelves were not included in this model, as the model was only used to look at temperature and rain resistance and was not meant to be used to measure airflow or function as an enclosure after data collection.



Figure 21: Back View

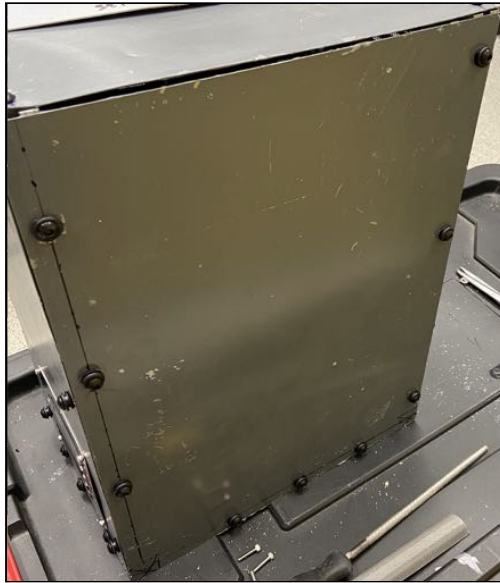

Figure 22: Bottom View



Figure 23: Front View

Figure 24: Left View



Figure 25: Right View

To represent the electronics housed in enclosures, an 80-watt heating pad was used as shown in Figure 21. It was first soldered to a 3 prong plug so that it could be plugged into a variac. A variac adjusts AC voltage, and adjusted the voltage to the heating pad to 40% so that the pad had a wattage of 32 Watts, about  $\frac{1}{3}$  of 98 Watts.

A data acquisition system (DAQ) and thermocouples were used to collect temperature measurements from the enclosure. The thermocouples rested against the walls of the

enclosure, one just under the heating pad and the other underneath the louvers on the top right of the enclosure. The DAQ and thermocouples were used to record the wall temperature over time.

To model the conditions under which the enclosure is most likely to fail (high heat, humidity, rain), the enclosure was placed in the Temperate room of the Duke Research Greenhouse for 2.4 hours. This room had a dry bulb temperature of 77.6°F (25.33°C) and a relative humidity of 76.4%. Additionally, greenhouse staff doused the enclosure with water while watering the nearby plants. The enclosure was placed on bricks to allow air to flow out through the bottom cutout.



Figure 26: Back View of Enclosure Testing



Figure 27: Top View of Testing Setup



Figure 28: Testing Setup

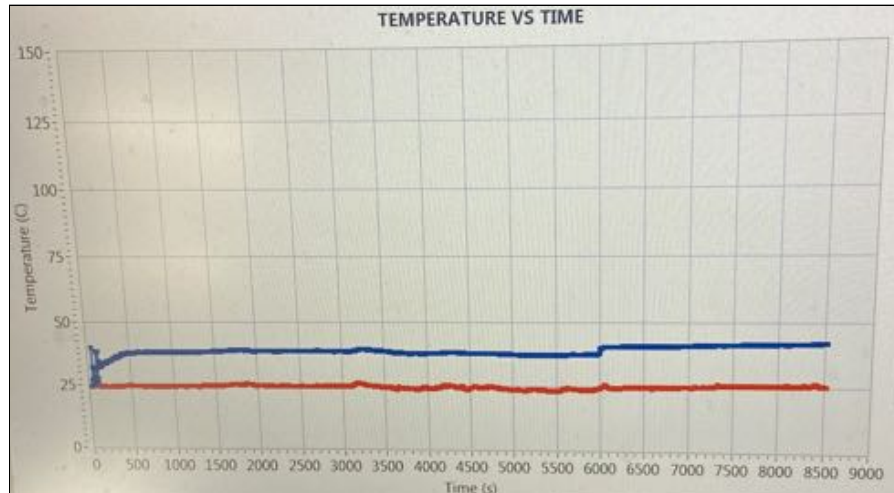

Figure 29: Testing Results

### **Interpretation of Results**

As shown in the figure above, the first thermocouple, represented by the blue line, had a much higher temperature than the second thermocouple. Both thermocouples had a spike at 6000 seconds. As the temperature increase appears to be the same for both areas of the enclosure, this was likely due to the temperature in the entire greenhouse being adjusted.

The spikes in the blue line from 0-100 seconds are due to the thermocouple being moved to ensure it was close to the heating pad. Overall, both areas remained at the same temperature throughout the data collection period with the thermocouple against the louver at 25°C, and the thermocouple beneath the heating pad at 38.75°C.

Further, after testing, the inside of the enclosure was examined to determine if any water had condensed or entered when the enclosure was sprayed. No water droplets were found, which suggests that this model is successful at keeping electronics dry.

### **Comparison to Scale CAD model**

The data collected at the greenhouse varied from that predicted by the scale CAD model. The results of the analysis on the scale CAD model are shown in Figures 30 and 31. The flow simulation yielded higher temperatures than observed during data collection. This could be the result of the coefficient of heat transfer being a



conservative estimate or that the perforated surface used in the CAD restricted more airflow than the mesh used in the physical model. This could also be the result of a silicon heat pad being used to test the physical model, whereas the heat source in the simulation was modeled as aluminum.

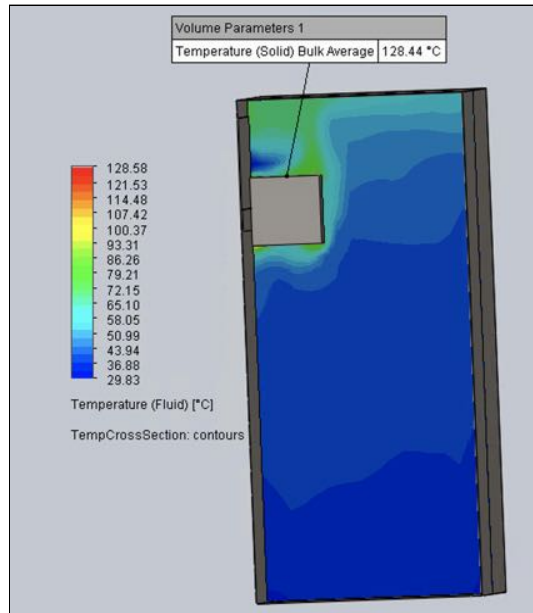

Figure 30: Cross Section of Air in Model

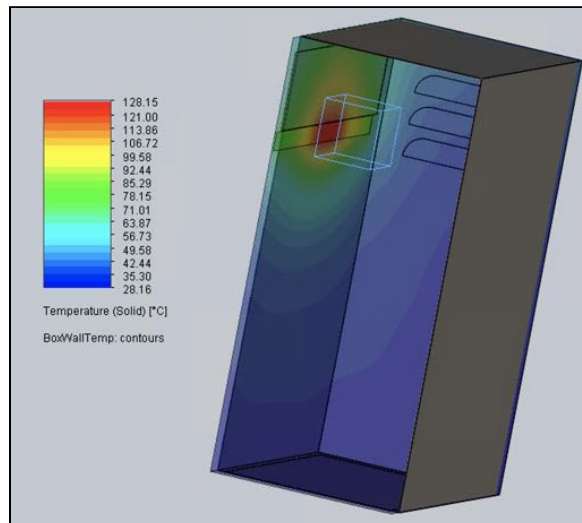

Figure 31: Wall Temperature of Model

### **Testing Part 2**

To better test how the model enclosure would react to rain, it was left outside during intermittent rain for 90 minutes. While the heating pad was still attached to the model, it was not connected to a power source and did not give off heat. No temperature data of the enclosure were collected, but the ambient temperature was 57-63°F (13.89-17.22°C) .



Figure 32: Outdoor Testing

After 90 minutes, the enclosure was brought inside, and the interior was examined to determine if rain had entered. Water droplets were found on almost all of the interior walls towards the bottom. On the front wall opposite the overhang, water droplets were found higher up. This suggests that the overhang was able to protect the electronics from water falling on the top of the enclosure from the hose in the greenhouse, but it does not stop rain from entering when wind is able to push it at different angles.



Figure 33: Example of Water on Model Interior

## VII. Limitations/Areas of Improvement

There are several potential sources of limitations. First, the coefficient used in the flow simulation was an estimate and may have modeled too much or too little heat transfer between the environment and enclosure walls. Second, the models tested were designed from previously successful enclosures and my own brainstormed ideas, but

they by no means represent the only possible enclosures. Models not tested in this project may be just as successful or more so. Further, the louvers used in the scale model were not an exact match to those used in the CAD model, as louvers were not available in that size. As discussed above, the louvers in the CAD model needed to be doubled in size in order for the flow simulation to run. This may have led to an overestimation of the volume of airflow that enters through the louvers. Additionally, the mesh used in SolidWorks was rectangular shaped, not a diamond, as the software did not allow for that shape.

## **VIII. Acknowledgements**

This project would not have been possible without the advice and support of the people below. Many thanks for your time and help in making this a success!

- Dr. Rebecca Simmons, Duke University Pratt School of Engineering
- Mr. Pat McGuire, Duke University Pratt School of Engineering
- Dr. Nico Hotz, Duke University Pratt School of Engineering
- Dr. Adrian Bejan, Duke University Pratt School of Engineering
- Mr. David Smoot, Duke University Pratt School of Engineering Class of 2021
- Mr. Eric Becker, World Wildlife Fund
- Mr. Tim van Dam, Smart Parks
- Mr. Juan Swart, Techlink
- Mr. Jorge Fidhel Gonzalez, Duke University Research Greenhouse
- Ms. Kristin Dimac-Stohl, Duke University Research Greenhouse

## **IX. Author Biography**

Ashley Rosen is a senior at the Duke University Pratt School of Engineering, pursuing a B.S.E in Mechanical Engineering with a Certificate in Energy and the Environment. She has worked for Peloton as a Hardware Intern and World Wildlife Fund as a Conservation Technology Intern. She is heavily involved in environmental spaces at Duke and serves as the President of Duke's Undergraduate Environmental Union. She mentors middle school and high school girls interested in STEM (Science, Technology, Engineering, and Math) through Duke FEMMES+ and is a member of an interdisciplinary engineering team working to develop a low-cost model for the diagnosis of postpartum hemorrhaging.

She is passionate about finding engineering solutions to challenges within the field of wildlife conservation and looks forward to using her engineering degree to have a positive impact.